

Z2515

 = NiCr-Ni

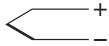

► Info

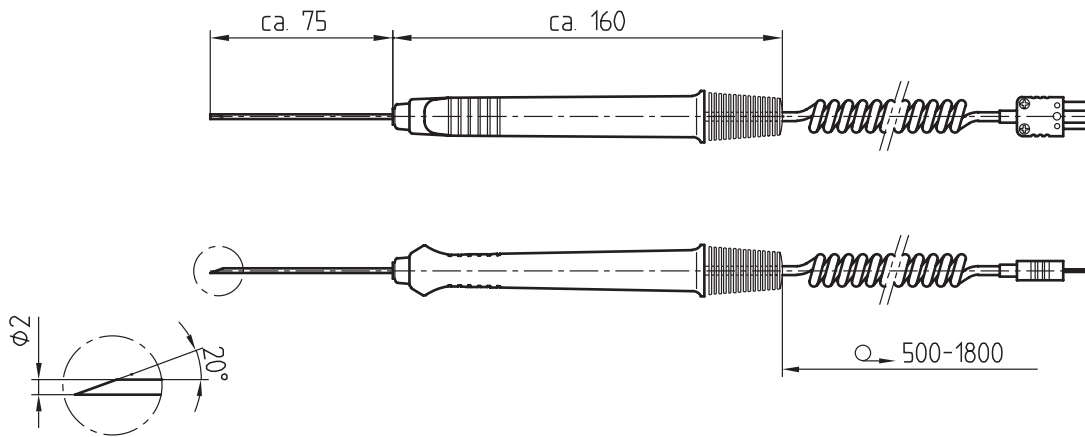

max. °C	Nr./No.
600	Z2515

Z252

 = NiCr-Ni



► Info

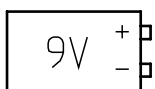
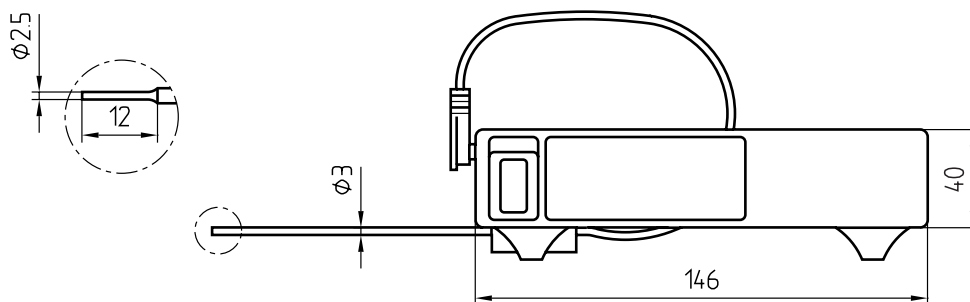

max. °C	Nr./No.
600	Z252

This is trial version
www.adultpdf.com