

Q45U Ultrasonic Sensors with Analog Outputs (Long Range)

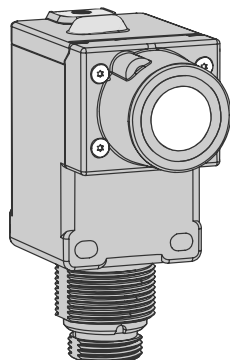

Datasheet

Piezoelectric proximity mode sensors with push-button programming of sensing window limits



- Ultrasonic proximity detection from 250 mm to 3.0 m (9.8 in to 118 in)
- Push-button TEACH-mode programming of sensing window limits
- Digital filtering for exceptional immunity to electrical and acoustic noise
- 15 DC to 24 V DC operation
- Selectable 0 V DC to 10 V DC voltage PNP or 4 mA to 20 mA current PNP analog outputs
- Selectable output slope: positive or negative with increasing target distance
- Wide operating temperature range of $-25\text{ }^{\circ}\text{C}$ to $+70\text{ }^{\circ}\text{C}$ ($-13\text{ }^{\circ}\text{F}$ to $+158\text{ }^{\circ}\text{F}$); all models include temperature compensation
- Rugged design for use in demanding sensing environments; rated IP67, NEMA 6P
- Choose models with an integral unterminated 2 m (6.5 ft) or 9 m (30 ft) cable, or with a 7/8 in-16UNF or M12 quick-disconnect connector
- Input for remote TEACH-mode programming of window limits



WARNING:

- **Do not use this device for personnel protection**
- Using this device for personnel protection could result in serious injury or death.
- This device does not include the self-checking redundant circuitry necessary to allow its use in personnel safety applications. A device failure or malfunction can cause either an energized (on) or de-energized (off) output condition.

Models

Models	Cable ¹	Output Type	Response Time
Q45ULIU64BCR	2 m (6.5 ft)	Selectable 0 V DC to 10 V DC or 4 mA to 20 mA, PNP	Adjustable from 80 milliseconds to 2.56 seconds
Q45ULIU64BCRQ	Integral 5-pin 7/8 in-16UNF male quick-disconnect connector		
Q45ULIU64BCRQ6	Integral 5-pin M12 male quick-disconnect connector		

Temperature Compensation

All models listed above feature temperature compensation. An increase in air temperature shifts both sensing window limits closer to the sensor. Conversely, a decrease in air temperature shifts both limits further away from the sensor. The shift is approximately 3.5% of the limit distance for a 20 °C change in temperature.

Temperature compensated models maintain the position of both sensing window limits to within 1% of each limit distance over the 0 °C to +50 °C (+32 °F to +122 °F) range, and to within 2.5% over the full operating range of $-25\text{ }^{\circ}\text{C}$ to $+70\text{ }^{\circ}\text{C}$ ($-13\text{ }^{\circ}\text{F}$ to $+158\text{ }^{\circ}\text{F}$).

¹ To order the 9 m (30 ft) cable models, add the suffix "W/30" to the cabled model number. For example, Q45ULIU64BCR W/30. Models with a quick disconnect connector require a mating cable.



Overview

Figure 1. Q45U with Analog Outputs Features

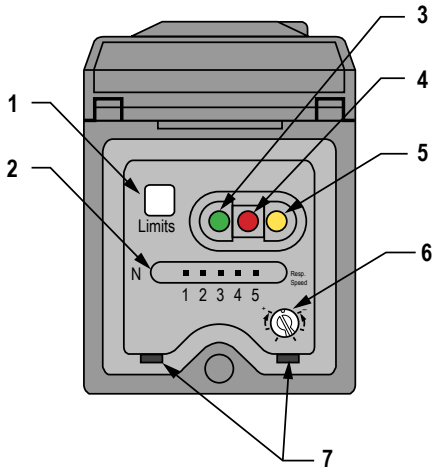

- 1 - Push button for programming sensing window limits
- 2 - 5-segment target position indicator (N = near)
- 3 - Green POWER indicator LED
- 4 - Red SIGNAL indicator LED
- 5 - Amber OUTPUT indicator LED
- 6 - Response adjustment
- 7 - Slots for removing inner cover

Status Indicators

Status indicator LEDs are visible through the transparent, o-ring sealed acrylic top cover. Indicator function in the Run mode is, as follows:

- The green LED is on when power is applied to the sensor and flashes to indicate a current output fault.
- The red LED is on when an echo is received and flashes at a rate proportional to echo strength.
- The amber LED is on when the target is within the operating window limits.

The 5-segment moving dot LED indicator displays the relative position of the target within the programmed sensing window. LED 1 flashes when the target is closer than the near limit. LED 5 flashes when the target is beyond the far limit.

Configuring a Sensor

Output Response Settings



Important: Remove power before making any internal adjustments.

Insert a small, flat-blade screwdriver into the two slots shown in [Figure 1](#). Lift up and remove the black inner cover to expose the 4-position DIP switch. Use these DIP switches to program the output slope, output mode, loss of echo, and min./max. output value default.

DIP Switch	Function	Settings	
1	Output slope	On = Output value increases with distance	<p>Figure 2. DIP Switches for Q45U Sensors</p>
		Off* = Output value decreases with distance	
2	Output mode	On = Current output enabled	
		Off* = Voltage output enabled	
3	Loss of echo	On = Min - Max Mode	
		Off* = Hold Mode	
4	Min-Max Default	On* = Default to maximum output value	
		Off = Default to minimum output value	

* Factory default settings.

DIP Switch 1: Output Slope

Figure 3. Output as a function of target position

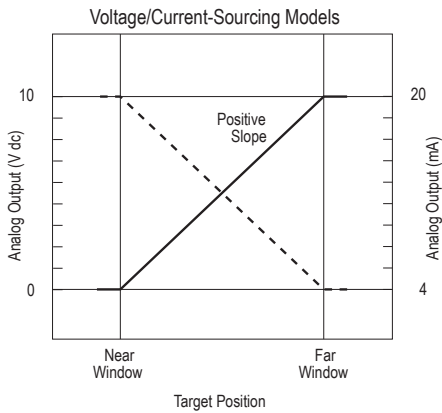

On = Direct = Output value (voltage or current) increases with increasing distance of the target from the sensor

Off = Inverse = Output value decreases with increasing distance of the target from the sensor (default setting)

DIP Switch 2: Output Mode

Configure the D/A driver to use either the current output or the voltage output driver. This output function can only be set with the power to the sensor turned off.

On = The 4 mA to 20 mA current output (white wire) is enabled

Off = The 0 V DC to 10 V DC voltage output (black wire) is enabled (default setting)

DIP Switch 3: Loss of Echo Mode

Select the output response to the loss of echo. Hold Mode maintains the output at the value present at the time of echo loss. Min-Max Mode drives the output to either the minimum value (0 V or 4 mA) or the maximum value (10 V or 20 mA) when the echo is lost.

On = Min-Max Mode

Off = Hold Mode (default setting)

DIP Switch 4: Min-Max Default

Select the output response to loss of echo when Min-Max Mode is selected by DIP switch 3.

On = Default to maximum output value at loss of echo (default setting)

Off = Default to minimum output value at loss of echo

Response Speed Adjustments

Set the output response speed by aligning the slot of the single-turn potentiometer with one of the marked positions. There are six values for response speed, which relate directly to the number of sensing cycles over which the output value is averaged.

Position	Response Speed	Potentiometer Positions
1	80 milliseconds (2 cycles)	<p>Figure 4. Response adjustment positions</p> <p>This example shows the potentiometer set at position number 4. There are no numbers on the actual product label.</p>
2	160 milliseconds (4 cycles)	
3	320 milliseconds (8 cycles)	
4	640 milliseconds (16 cycles)	
5	1.28 seconds (32 cycles)	
6	2.56 seconds (64 cycles)	

Programming the Window Limits

Use the **Limits** button, located under the transparent top cover, to program the near and the far limits.

The near limit may be set as close as 250 mm (9.8 inches) and the far limit may be set as far as 3.0 m (118 inches) from the transducer face. Minimum window width is 25 mm (1 inch). When possible, use the actual target to be sensed when setting the window limits.

The following procedure begins with the sensor in Run mode.

1. Access Programming Mode. Push and hold the **Limits** button until the green indicator LED turns off (approximately 2 seconds).

LED Indicator	Status
Green	Turns off
Amber	On to indicate the sensor is ready to learn the first limit
Red	Flashes to indicate the strength of the echo, or it is off if no target is present

2. Set the first limit (or single set point). Place the target at the first limit and press the **Limits** button for less than 2 seconds.

LED Indicator	Status
Green	Remains off
Amber	Flashes at 2 Hz to indicate the sensor is ready to learn the second limit
Red	On for a moment, then resumes flashing to indicate the strength of echo

3. Set the second limit. Place the target at the second limit and press the **Limits** button for less than 2 seconds.

LED Indicator	Status
Green	Remains off, then turns on (returns to Run mode)
Amber	On for a moment, then is either on or off to indicate the output state (returns to Run mode)
Red	On for a moment, then resumes flashing to indicate the strength of the echo (returns to Run mode)

Notes Regarding Window Limit Programming

1. Either the near or far limit may be programmed first.
2. There is a 2-minute time-out for programming the first limit. The sensor returns to Run mode with the previously programmed limits. There is no time-out between programming of the first and second limit.
3. Cancel the programming sequence at any time by pressing and holding the button for longer than 2 seconds. The sensor returns to Run mode with the previously programmed limits.
4. If a limit is rejected during either programming step, the sensor reverts to the first limit programming step, indicated by the Green LED (off), the Red LED (flashing to indicate signal strength), and the Amber LED (on).
5. If both limits are accepted, the sensor returns to Run mode, which is indicated by the Green LED (on).
6. During limit programming, the 5-segment moving dot indicator displays the relative target position between 250 mm (9.8 inches) and 4.0 m (the maximum recommended far limit position is 3.0 m (118 inches)).
7. If the target is farther than 3.0 m (118 inches), the 5th segment of the moving dot indicator flashes to indicate that a valid echo is received, but the target is beyond the recommended 3.0 m (118 inches) maximum far limit.
8. If the target is held at the same position for programming of both limits, the sensor establishes a 50 mm-wide sensing window, centered on the target position.

Remote Programming the Window Limits

Connect the yellow wire of the sensor to a switch or process controller for remote programming of the sensing window limits. The programming procedure is the same as for the button. A remote programming input is generated when +5 V DC to 24 V DC is applied to the yellow wire. The timing diagrams define the required input pulses.

H = +5 V DC to 24 V DC

L = Less than 2 V DC (or open circuit)

Notes regarding remote window limit programming:

1. The button is disabled during remote limit programming. (The remote programming input is disabled during push button programming.)
2. Also see the notes regarding window limit programming.

Figure 5. Remote programming the window limits

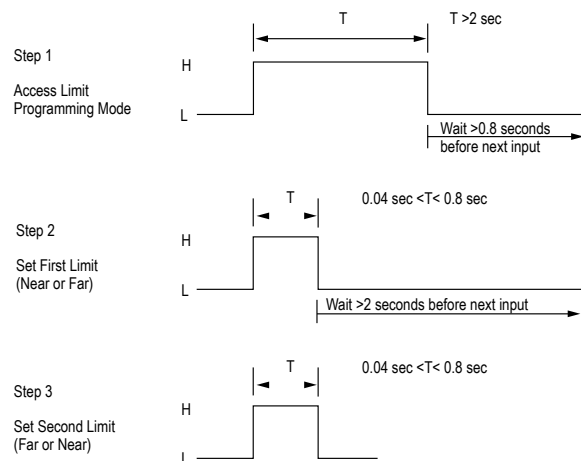

Wiring Diagrams for Q45U Sensors with Analog Outputs

Sensor with Attached Cable

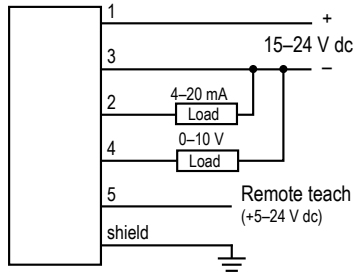

Banner Engineering Corp recommends the shield wire be connected to earth ground or DC common.

- 1 = brown
- 2 = white
- 3 = blue
- 4 = black
- 5 = gray or yellow

Sensor with 5-pin 7/8 in-16UNF Quick Disconnect

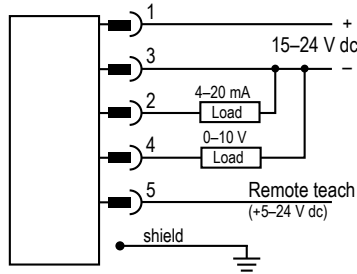

- 1 = brown
- 2 = white
- 3 = blue
- 4 = black
- 5 = yellow

Sensor with 5-pin M12 Quick Disconnect

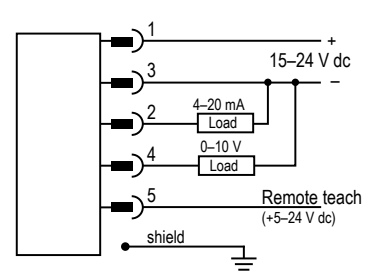

- 1 = brown
- 2 = white
- 3 = blue
- 4 = black
- 5 = gray

Specifications

Proximity Mode Range

Near limit: 250 mm (9.8 inches) min
 Far limit: 3.0 m (118 inches) max
 The far limit may be extended as far as 3.9 m for good acoustical targets (hard surfaces with area > 100 cm²)

Supply Voltage and Current

15 V DC to 24 V DC (10% maximum ripple) at 100 mA, exclusive of load

Supply Protection Circuitry

Protected against reverse polarity and transient voltages

Indicators

Three status LEDs:
 Green solid = power to sensor is ON
 Green flashing = current output fault detected (indicates that the 4-20 mA current path to ground has been opened)
 Amber solid = target is sensed within the window limits (Amber LED also indicates programming status during setup mode)
 Red flashing = indicates relative strength of received echo
 5-segment moving dot LED indicates the position of the target within the sensing window

Construction

Molded PBT thermoplastic polyester housing, o-ring sealed transparent acrylic top cover, and stainless steel hardware. Q45U sensors are designed to withstand 1200 psi washdown. The base of cabled models has a 1/2"-14NPS internal conduit thread

Connections

2 m (6.5 ft) or 9 m (30 ft) attached cable, integral 5-pin 7/8 in-16UNF male quick-disconnect connector, or integral 5-pin M12 male quick-disconnect connector

Certifications



Banner Engineering
 Europe Park Lane,
 Culliganlaan 2F bus 3,
 1831 Diegem,
 BELGIUM



Turck Banner LTD
 Blenheim House,
 Blenheim Court,
 Wickford, Essex SS11
 8YT, Great Britain

Output Configuration

One voltage PNP and one current PNP; one or the other output is enabled by internal programming switch #2. Output function may be programmed by a 4-position DIP switch located on top of the sensor, beneath the transparent o-ring sealed acrylic cover.

Output Rating

Voltage PNP: 0 V DC to 10 V DC, 10 mA maximum
 Current PNP: 4 mA to 20 mA, 1 ohm to 500 ohm impedance

Output Protection Circuitry

Both outputs are protected against continuous overload and short circuit

Performance Specifications

Sensing Repeatability: $\pm 0.1\%$ of the measured distance (± 0.50 mm minimum)
 Sensing Resolution: 0.50 mm (0.02 in)
 Analog Output Resolutions: 2 mV, 3 μ A

Environmental Rating

Leakproof design is rated IP67; NEMA 6P

Operating Temperature

Temperature: -25 to $+70$ °C (-13 to $+158$ °F)
 Maximum relative humidity: 100%

Vibration and Mechanical Shock

All models meet Mil. Std. 202F requirements. Method 201A (Vibration: 10 to 60Hz max., double amplitude 0.06-inch, maximum acceleration 10G). Method 213B conditions H & I (Shock: 75G with unit operating; 100G for nonoperation). Also meets IEC 947-5-2 requirements: 30G, 11 ms duration, half sine wave

Application Notes

Minimum target size: 50 mm x 50 mm aluminum plate at 3.0 m (118")

Performance Curves

Effective Beam with 100 × 100 mm Plate Target (Typical)

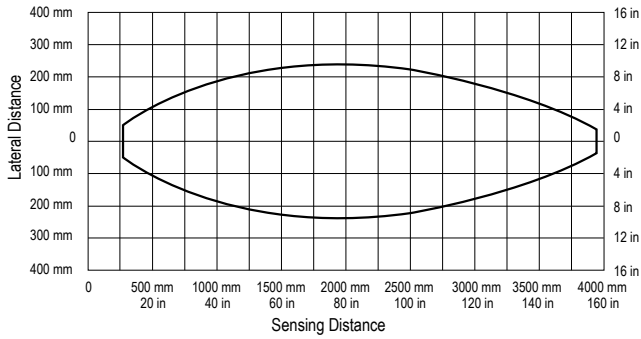

Effective Beam with 2.5 cm Rod Target (Typical)

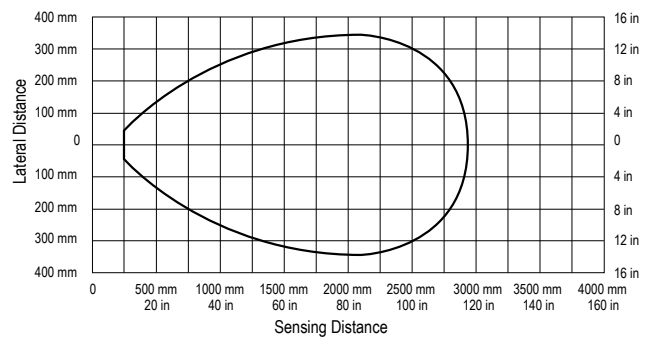

Dimensions

Cabled Models

5-pin 7/8 in-16UNF QD Models

5-pin M12 QD Models

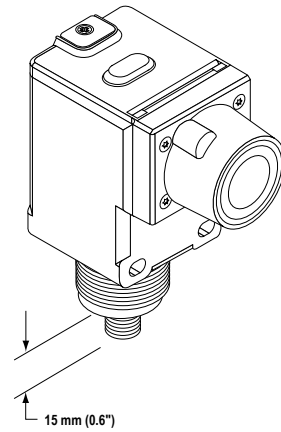
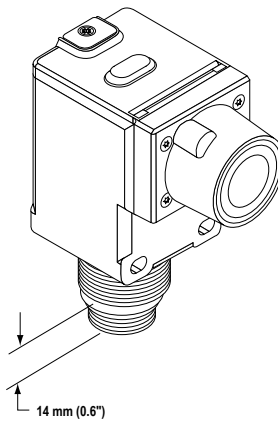
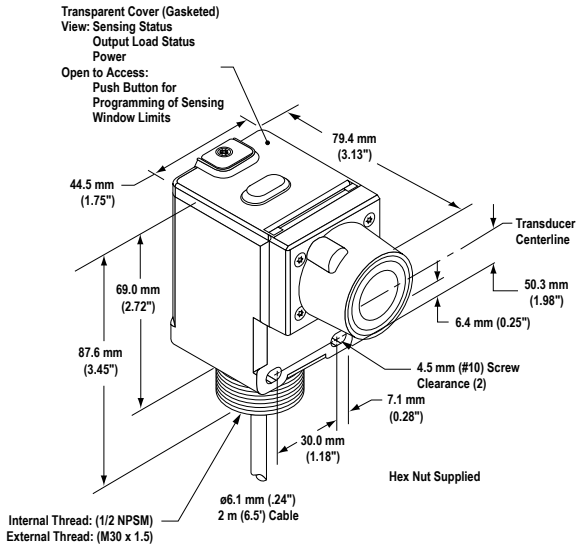

Accessories

Cordsets

5-Pin 7/8-in Cordsets with Shield—Single Ended				
Model	Length	Style	Dimensions	Pinout (Female)
MBCC2-506	2 m (6.56 ft)	Straight		<p>1 = Brown 2 = White 3 = Blue 4 = Black 5 = Yellow</p>
MBCC2-512	4 m (13.1 ft)			
MBCC2-530	9 m (29.5 ft)			

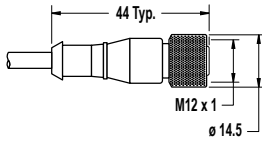
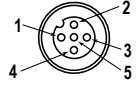
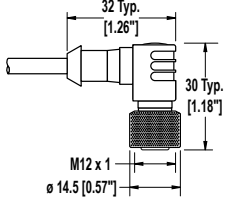
5-Pin Threaded M12 Cordsets with Shield—Single Ended				
Model	Length	Style	Dimensions	Pinout (Female)
MQDEC2-506	2 m (6.56 ft)	Straight		 <p>1 = Brown 2 = White 3 = Blue 4 = Black 5 = Gray</p>
MQDEC2-515	5 m (16.4 ft)			
MQDEC2-530	9 m (29.5 ft)			
MQDEC2-550	15 m (49.2 ft)			
MQDEC2-575	23 m (75.44 ft)			
MQDEC2-5100	30.5 m (100 ft)			
MQDEC2-506RA	2 m (6.56 ft)	Right-Angle		
MQDEC2-515RA	5 m (16.4 ft)			
MQDEC2-530RA	9 m (29.5 ft)			
MQDEC2-550RA	15 m (49.2 ft)			
MQDEC2-575RA	23 m (75.44 ft)			
MQDEC2-5100RA	31 m (101.68 ft)			

Brackets

SMB30S

- Swivel bracket with 30 mm mounting hole for sensor
- Adjustable captive swivel ball
- Black reinforced thermoplastic polyester
- Stainless steel mounting and swivel locking hardware included

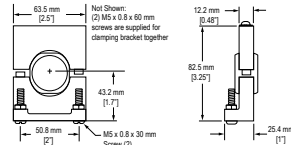

SMB30C

- 30 mm split clamp, black PBT bracket
- Stainless steel mounting hardware included
- Mounting hole for 30 mm sensor

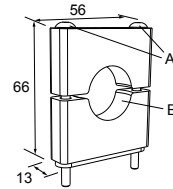

Hole center spacing: A=ø 45
Hole size: B=ø 27.2

SMB30MM

- 12-ga. stainless steel bracket with curved mounting slots for versatile orientation
- Clearance for M6 (1/4 in) hardware
- Mounting hole for 30 mm sensor

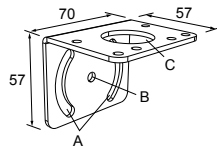

Hole center spacing: A = 51, A to B = 25.4
Hole size: A = 42.6 x 7, B = ø 6.4, C = ø 30.1

Banner Engineering Corp. Limited Warranty

Banner Engineering Corp. warrants its products to be free from defects in material and workmanship for one year following the date of shipment. Banner Engineering Corp. will repair or replace, free of charge, any product of its manufacture which, at the time it is returned to the factory, is found to have been defective during the warranty period. This warranty does not cover damage or liability for misuse, abuse, or the improper application or installation of the Banner product.

THIS LIMITED WARRANTY IS EXCLUSIVE AND IN LIEU OF ALL OTHER WARRANTIES OR IMPLIED (INCLUDING, WITHOUT LIMITATION, ANY WARRANTY OF MERCHANTABILITY OR FITNESS FOR A PARTICULAR PURPOSE), AND WHETHER ARISING UNDER COURSE OF PERFORMANCE, COURSE OF DEALING OR TRADE USAGE.

This Warranty is exclusive and limited to repair or, at the discretion of Banner Engineering Corp., replacement. **IN NO EVENT SHALL BANNER ENGINEERING CORP. BE LIABLE TO BUYER OR ANY OTHER PERSON OR ENTITY FOR ANY EXTRA COSTS, EXPENSES, LOSSES, LOSS OF PROFITS, OR ANY INCIDENTAL, CONSEQUENTIAL OR SPECIAL DAMAGES RESULTING FROM ANY PRODUCT DEFECT OR FROM THE USE OR INABILITY TO USE THE PRODUCT, WHETHER ARISING IN CONTRACT OR WARRANTY, STATUTE, TORT, STRICT LIABILITY, NEGLIGENCE, OR OTHERWISE.**

Banner Engineering Corp. reserves the right to change, modify or improve the design of the product without assuming any obligations or liabilities relating to any product previously manufactured by Banner Engineering Corp. Any misuse, abuse, or improper application or installation of this product or use of the product for personal protection applications when the product is identified as not intended for such purposes will void the product warranty. Any modifications to this product without prior express approval by Banner Engineering Corp will void the product warranties. All specifications published in this document are subject to change; Banner reserves the right to modify product specifications or update documentation at any time. Specifications and product information in English supersede that which is provided in any other language. For the most recent version of any documentation, refer to:

www.bannerengineering.com.

For patent information, see www.bannerengineering.com/patents.