

# KISTLER

measure. analyze. innovate.



## Product Catalog

Sensors and Solutions for Cutting Force Measurement

# Kistler – Your Partner for Efficiency and Quality.

Sensors and systems for the measurement of forces and torques, for the analysis of force-distance and force-time characteristics and for the documentation of quality data in assembly and product testing are only one of the modules of the industry solutions from Kistler Instrumente AG. In addition to assembly and testing technology, we also offer special sensors and monitoring systems for mechanical production, for fuel engines, for automotive engineering, plastic processing and biomechanics.

Numbered among the core competencies at Kistler are development, production and utilization of sensor for the measurement of pressure, force, torque and acceleration. The measurement signals thus acquired can be processed and utilized through Kistler know-how and our electronics systems. The objective is the analysis of physical procedures. These are applied in the control and optimization of processes and in the enhancement of product quality in the manufacturing sector. Each year, Kistler invests 10 % of its revenues in research and development, thus providing innovative and economical solutions at the state-of-the-art of knowledge.

The Kistler Group is comprised of 30 Group companies. These are present around the globe in 30 countries at a total of 53 sites. Selected representatives distribute Kistler products and solutions in more than 30 additional countries.



Crystals form the basis of piezoelectric sensors

# Content.



Milling of an impeller with RCD Type 9170A...

<b>Dynamometer Selection Chart</b>	4
<b>Measuring</b>	
Stationary Dynamometers	8 ... 17
Type 9119AA1/9119AA2	8 ... 9
Type 9129AA	10 ... 11
Type 9139AA	12
Type 9255C	13
Type 9257B	14
Type 9272	15
Type 9253B22/9253B23	16
Type 9366CC...	17
Rotating Dynamometers	18 ... 19
Type 9170A...	18
Type 9171A...	19
<b>Amplifying and Analyzing</b>	20
Charge Amplifiers	21 ... 23
Type 5080A...	21
Type 5070A...	22
Type 5171A...	23
Data Acquisition System	24
Type 5697A...	24
Software	24
Type 2825A...	24
Connecting Cables, High Insulation	25
Type 1677A5	25
Type 1679A5	25
Type 1687B5	25
Type 1689B5	25
Connecting Cables, Low Resistance	25
Type 1700A111A2	25
Type 1700A113A2	25
Type 1200A27	25
<b>Measuring Chains</b>	26 ... 27

# Dynamometer Overview.

## Dynamometers for Measurement of the Cutting Forces

Kistler offers a comprehensive program of dynamometers for the measurement of forces and torques in cutting processes. Many of these measurement devices can be used for various tasks. This provides the user with a maximum amount of flexibility.

Stationary dynamometers differ mainly with respect to the direction of the pretension. The thermal energy that arises during cutting processes has a negative influence on the measurement signals. Dynamometers with horizontal pretension act against these negative influences and minimize them. They are therefore outstandingly suitable for measuring the cutting forces. Nonetheless, it is also true that dynamometers with vertical pretension have advantages of their own, e.g. the larger force range.

## Selection Table

The adjacent selection table helps the user make a suitable selection. Dynamometers that are specially suitable for a desired machining application are marked with ++. The dynamometer can also be used for applications that are marked with +. Limitations must be taken into account in such cases, e.g. with respect to accuracy or dynamic behavior.

	Type	Measurable components	Minimized influences of temperature	Turning	Milling	Drilling/tapping	Surface grinding	Micro-machining
rotating	9170A	$F_x, F_y, F_z, M_z$	no		+	++		
	9171A	$F_x, F_y, F_z, M_z$	no		++	++		
stationary	9119AA1	$F_x, F_y, F_z$	yes		++	+	++	++
	9119AA2	$F_x, F_y, F_z$	yes	++	++	+	++	+
	9129AA	$F_x, F_y, F_z$	yes	++	++	+	++	
	9139AA	$F_x, F_y, F_z$	yes	+	++	+	++	
	9257B	$F_x, F_y, F_z$	no	+	++	+	++	
	9253B	$F_x, F_y, F_z$	no		+	+	+	
	9255C	$F_x, F_y, F_z$	no		++	+	++	
	9272	$F_x, F_y, F_z, M_z$	no	+	+	++		
9366CC	$F_x, F_y, F_z$	no		++	+	+		

++ suitable  
+ limited suitability

# Measuring.

## Measuring with Dynamometers

The measuring element is the core of every measuring chain. This records the physical variable to be measured and forwards it to subsequent devices in the form of a signal. The measuring elements used for the measurement of the forces and torques in the cutting processes are called Dynamometers and are all based on the piezoelectric measurement principle.

As a basic rule, a distinction is to be made between two families of dynamometers. On the one hand, there are the stationary dynamometers, that are mainly set up on the machinery table, while on the other hand there are the rotating Dynamometers – also called RCDs – that are retracted into the spindle via the spindle interface and rotate along with it.

## Stationary Dynamometers

A stationary dynamometer is often the connecting element between the machine table of the machine tool and the workpiece. The workpiece is fastened on the dynamometer with which the reaction forces in manufacturing processes such as milling or drilling are measured. Stationary dynamometers are also used for turning applications. These are fitted directly to the turret with corresponding machine adaptors. The tool is placed on the dynamometer with a suitable tool holder. Depending on the structure, the forces that arise are recorded by one or more multi-component force sensors and are available at the connector of the dynamometer in the form of charge signals.

## Rotating Dynamometers

Rotating dynamometers (RCD) are mounted directly into the machine spindle via the spindle interface. The tool is mounted at the RCD with the aid of a tool holder. The RCD is used mainly in milling and drilling processes. In contrast to stationary dynamometers, only one multi-component sensor is installed in each rotating dynamometer. In addition to the sensor, the rotor also contains the charge amplifiers, i.e. the electronics that converts the charge into voltage, and the telemetry electronics. The measurement data is forwarded to the stationary part of the measuring chain via near-field telemetry, where it is subsequently made available as analog voltage signals.

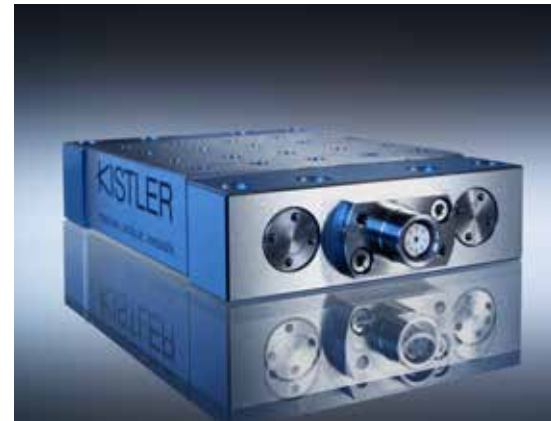

Stationary Dynamometer Type 9129AA



Rotating Dynamometer Type 9170A

# Multi-Component Force and Moment Measurement.

## Special Feature of Stationary Dynamometers

All stationary 3-component dynamometers have the property of being able to be utilized as both a purely 3-component dynamometer and as a 6-component dynamometer.

This is made possible by the corresponding switching of the four 3-component force sensors in the interior of the dynamometer. The forces  $F_x$ ,  $F_y$  and  $F_z$  are directly measured thereby, whereas the torques  $M_x$ ,  $M_y$  and  $M_z$  are calculated with the aid of the individual force components and the sensor distances.

## Cutting Force Measurement

With respect to the cutting force measurement, in addition to the measurement of the three orthogonal force components  $F_x$ ,  $F_y$  and  $F_z$ , only the torque  $M_z$  is relevant for the determination of the drilling torque.

## General Force Measurement

There are however numerous other measurement tasks in addition to the cutting force measurement for which not only the three components of the resulting force are of interest, but also the three components of the resulting torque vector. This is particularly true in cases where the point of applied force does not change during the measurement, which means that the distances required for the calculation of the torques remain constant.

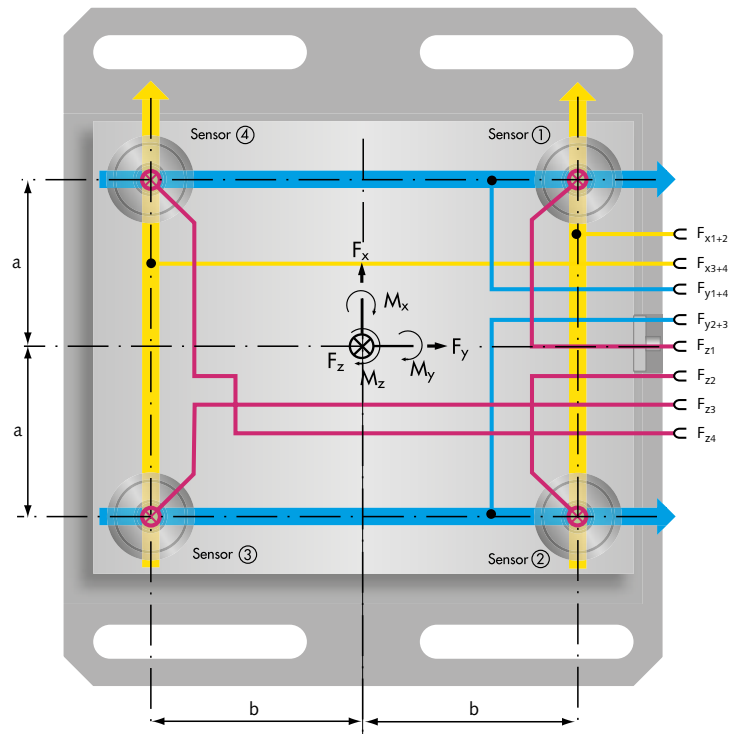

### Calculation of the Three Forces $F_x$ , $F_y$ , $F_z$ and Three Moments $M_x$ , $M_y$ , $M_z$

$$\begin{aligned}
 F_x &= F_{x1+2} + F_{x3+4} \\
 F_y &= F_{y1+4} + F_{y2+3} \\
 F_z &= F_{z1} + F_{z2} + F_{z3} + F_{z4} \\
 M_x &= b ( F_{z1} + F_{z2} - F_{z3} - F_{z4} ) \\
 M_y &= a ( -F_{z1} + F_{z2} + F_{z3} - F_{z4} ) \\
 M_z &= b ( -F_{x1+2} + F_{x3+4} ) + a ( F_{y1+4} - F_{y2+3} )
 \end{aligned}$$

### Calculating the Forces and Moments

Three forces  $F_x$ ,  $F_y$  and  $F_z$  and the moments  $M_x$ ,  $M_y$  and  $M_z$  are calculated with Software DynoWare or analog with the 6-component summing amplifier in the charge amplifier. To calculate the moments, the distance of the sensors must be included.

### 3-core connecting cable

### 8-core connecting cable

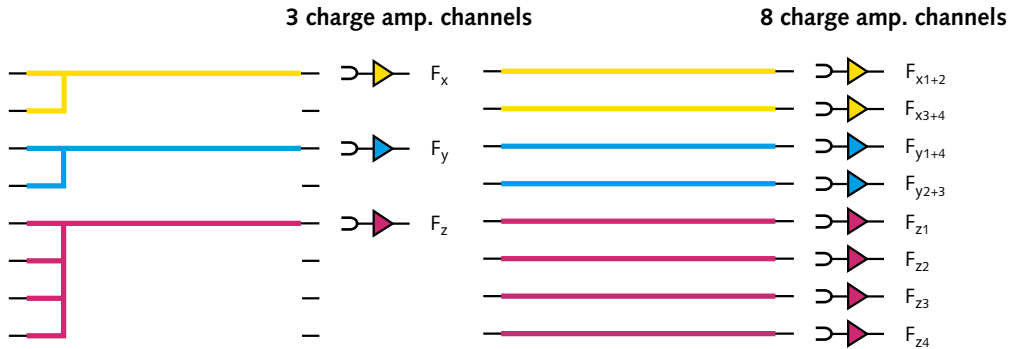

#### 3-component force measurement

In 3-component force measurement, the eight output signals from the dynamometer, as shown in the illustration, are summed in the three-core connecting cable. Three charge amplifiers are needed to convert the charge signal to a proportional output voltage.

#### 6-component force measurement

In 6-component force and moment measurement, the eight output signals are fed directly to the eight charge amplifiers by the eight-core connecting cable. These convert the charging signals into proportional output voltages and also calculate, depending on the specification of the charge amplifier, the torques  $M_x$ ,  $M_y$  and  $M_z$ .

#### In General, a 6-Component Measuring System Provides

- The three components of the resultants of all applied forces, their direction but not their location in space
- The three components of the resulting moment vector related to the coordinate origin

# Stationary Dynamometers

## Multi-Component Dynamometer up to 4 kN

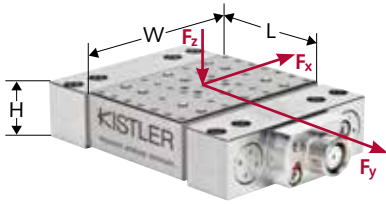

Technical Data	Type	9119AA1	9119AA2
Measuring range			
$F_x, F_y, F_z$	kN	-4 ... 4	-4 ... 4
Calibrated measuring range			
$F_x, F_y, F_z$	N	0 ... 4 000	0 ... 4 000
	N	0 ... 400	0 ... 400
	N	0 ... 40	0 ... 40
Sensitivity			
$F_x, F_z$	pC/N	$\approx -26$	$\approx -26$
$F_y$	pC/N	$\approx -13$	$\approx -13$
Natural frequency			
$f_n(x)$	kHz	$\approx 6,0$	$\approx 4,3$
$f_n(y)$	kHz	$\approx 6,4$	$\approx 4,6$
$f_n(z)$	kHz	$\approx 6,3$	$\approx 4,4$
Pretensioning direction		horizontal	horizontal
Operating temperature range	°C	-20 ... 70	-20 ... 70
LxWxH	mm	39x80x26	55x80x26
Weight	g	930	1 350
Degree of protection IEC/EN 60529 (w. conn. cable)		IP67	IP67
Connection		Fischer flange 9 pol. neg.	Fischer flange 9 pol. neg.

### Characteristics

The dynamometer with the smallest mounting dimensions. As a result of the optimized structure and the choice of selected materials, natural frequencies of more than 6 kHz are reached in all 3 force directions (Type 9119AA1). Thanks to the utilization of high-sensitivity crystals in the dynamometer, sensitivities are achieved that are three times as great as those of conventional dynamometers. This enables accurate measurements of the smallest of forces. The horizontal pretensioning direction guarantees minimal influences of thermal effects on the measurement signals.

### Accessories

Connecting cable Type 1687B5/1689B5 (3-comp.)  
Connecting cable Type 1677A5/1679A5 (6-comp.)

**Data sheet** 9119AA1\_003-060  
9119AA2\_003-055

**CAD Download-Service**  
<http://kistler.partcommunity.com>

### Applications

Cutting force measurement with minimal temperature drift in micro-machining, hard turning, high speed machining and ultra-precision machining of brittle materials.



Grinding with dynamometer Type 9119AA2



# Stationary Dynamometers

## 3-Component System for Measuring Cutting Force During Turning up to 3 kN

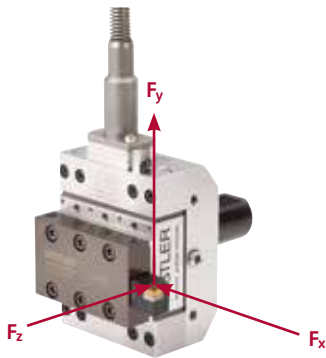

Technical Data	Type	9119AA2 <sup>1)</sup>
Measuring range		
$F_x, F_z$	kN	-2 ... 2 <sup>2)</sup>
$F_y$	kN	-3 ... 3 <sup>2)</sup>
Calibrated measuring range		
$F_x, F_z$	kN	0 ... 2
	kN	0 ... 0,2
$F_y$	kN	0 ... 3
	kN	0 ... 0,3
Sensitivity		
$F_x, F_z$	pC/N	≈-26
$F_y$	pC/N	≈-13
Natural frequency		
$f_n(x)$	kHz	≈1,25 <sup>3)</sup>
$f_n(y)$	kHz	≈1,5 <sup>3)</sup>
$f_n(z)$	kHz	≈2,5 <sup>3)</sup>
Operating temperature range	°C	-20 ... 70
Clamping surface	mm	55x80
Weight	g	depending on adaptor
Degree of protection IEC/EN 60529 (w. conn. cable)		IP67
Connection		Fischer flange 9 pol. neg.

<sup>1)</sup> with adaptors Type 9119A...

<sup>2)</sup> depending on adaptor

<sup>3)</sup> applies to dynamometer Type 9119AA2 with machine adaptor Type 9119AB30S and toolholder Type 9119AE16, with tool (280 g)

### Characteristics

This is a modular measuring system based on the dynamometer Type 9119AA2. Thanks to the utilization of high-sensitivity sensors, even the smallest of forces can be measured precisely. The assembling of machine adaptors and tool holders is simple. A wide variety of conventional adaptors that fit the dynamometer Type 9119AA2 is available.

### Accessories

Machine adaptor with straight shank adaptor (VDI) Type 9119AB...  
 Machine adaptor with Capto Type 9119AC...  
 Machine adaptor with HSK-T Type 9119AH...  
 Toolholder for machine tool Type 9119AE...  
 Toolholder for boring bar Type 9119AF...  
 Connecting cable Type 1687B5/1689B5 (3-comp.)

**Data sheet** 9119AA2\_003-055

### CAD Download-Service

<http://kistler.partcommunity.com>

### Applications

Measurement of small forces with minimal temperature drift while turning on lathes with small turrets.

# Stationary Dynamometers

## Multi-Component Dynamometer with Top Plate 90x105 mm up to 10 kN

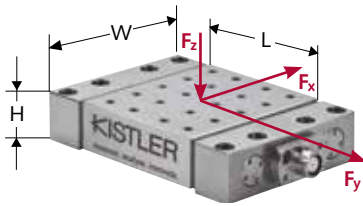

Technical Data	Type	9129AA
Measuring range		
$F_x, F_y, F_z$	kN	-10 ... 10
Calibrated measuring range		
$F_x, F_y, F_z$	kN	0 ... 10
	kN	0 ... 1
	kN	0 ... 0,1
Sensitivity		
$F_x, F_z$	pC/N	$\approx -8$
$F_y$	pC/N	$\approx -4,1$
Natural frequency		
$f_n(x)$	kHz	$\approx 3,5$
$f_n(y)$	kHz	$\approx 4,5$
$f_n(z)$	kHz	$\approx 3,5$
Pretensioning direction		horizontal
Operating temperature range	°C	0 ... 70
LxWxH	mm	90x105x32
Weight	kg	3,2
Degree of protection IEC/EN 60529 (w. conn. cable)		IP67
Connection		Fischer flange 9 pol. neg.

### Characteristics

The low profile and the wide measuring range make this dynamometer the ideal instrument for measurements on precision machine tools. The structure guarantees high natural frequencies in all three force directions. Negative influences of temperature effects during the measurement are significantly reduced by the horizontal pretensioning direction.

### Accessories

Connecting cable Type 1687B5/1689B5 (3-comp.)  
Connecting cable Type 1677A5/1679A5 (6-comp.)

**Data sheet** 9129AA\_000-709

### CAD Download-Service

<http://kistler.partcommunity.com>

### Applications

Cutting force measurement with minimal temperature drift while milling, turning, surface grinding and drilling of mid-sized structural components.



Milling with dynamometer Type 9129AA

# Stationary Dynamometers

## 3-Component Measuring System for Cutting Force Measurement During Turning up to 8 kN

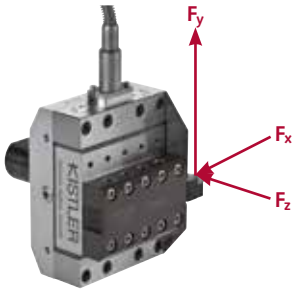

Technical Data	Type	9129AA <sup>1)</sup>
Measuring range (max. allowable)		
$F_x, F_z$	kN	-5 ... 5 <sup>2)</sup>
$F_y$	kN	-8 ... 8 <sup>2)</sup>
Calibrated measuring range		
$F_x, F_z$	kN	0 ... 5
	kN	0 ... 0,5
$F_y$	kN	0 ... 8
	kN	0 ... 0,8
Sensitivity		
$F_x, F_z$	pC/N	≈-8
$F_y$	pC/N	≈-4,1
Natural frequency		
$f_n(x)$	kHz	≈1,5 <sup>3)</sup>
$f_n(y)$	kHz	≈1,5 <sup>3)</sup>
$f_n(z)$	kHz	≈2,5 <sup>3)</sup>
Operating temperature range	°C	0 ... 70
Clamping surface	mm	90x105
Weight	kg	depending on adaptor
Degree of protection IEC/EN 60529 (w. conn. cable)		IP67
Connection		Fischer flange 9 pol. neg.

<sup>1)</sup> with adaptors Type 9129A...

<sup>2)</sup> depending on adaptor

<sup>3)</sup> applies to dynamometer Type 9129AA with machine adaptor Type 9129AB40 and toolholder Type 9129AE25, without tool

### Characteristics

Measurement system of modular construction based on the dynamometer Type 9129AA with large measurement range. Not only machine adaptors but also tool holders are mounted on the dynamometer with little effort. A wide variety of conventional adaptors that fit the dynamometer Type 9129AA is available.

### Accessories

Machine adaptor with straight shank adaptor (VDI) Type 9129AB...  
 Machine adaptor with Capto Type 9129AC...  
 Machine adaptor with clamping wedge Type 9129AD...  
 Toolholder for machine tool Type 9129AE...  
 Toolholder for boring bar Type 9129AF40  
 Connecting cable Type 1687B5/1689B5 (3-comp.)

**Data sheet** 9129A\_000-710

### CAD Download-Service

<http://kistler.partcommunity.com>

### Applications

Cutting force measurement with minimal temperature drift while turning on lathes with turrets.

# Stationary Dynamometers

Multicomponent Dynamometer with Top Plate 140x190 mm up to 30 kN

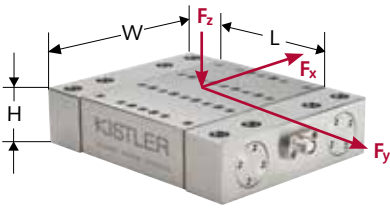

Technical Data	Type	9139AA
Measuring range		
$F_x, F_y, F_z$	kN	-30 ... 30
Calibrated measuring range	kN	0 ... 30
$F_x, F_y, F_z$	kN	0 ... 3
	kN	0 ... 0,3
Sensitivity		
$F_x, F_z$	pC/N	≈-8,2
$F_y$	pC/N	≈-4,2
Natural frequency		
$f_n(x)$	kHz	≈2,9
$f_n(y)$	kHz	≈2,9
$f_n(z)$	kHz	≈3,0
Pretensioning direction		horizontal
Operating temperature range	°C	-20 ... 70
LxWxH	mm	140x190x58
Weight	kg	≈12,9
Degree of protection IEC/EN 60529 (w. conn. cable)		IP67
Connection		Fischer Flansch 9 pol. neg.

### Characteristics

Compact and robust dynamometer which – due to the horizontal tensioning direction – to a large extent eliminates the negative effects of temperature variation during the measurement. The large measuring range permits force measurements in high-performance cutting processes.

### Accessories

Connecting cable Type 1687B5/1689B5 (3-comp.)  
Connecting cable Type 1677A5/1679A5 (6-comp.)

**Data sheet** 9139AA\_003-198

### CAD Download-Service

<http://kistler.partcommunity.com>

### Applications

Force measurements with minimal temperature drift in heavy machining processes, e.g. while milling, broaching and surface grinding.

# Stationary Dynamometers

## Multi-Component Dynamometer with Top Plate 260x260 mm up to 60 kN

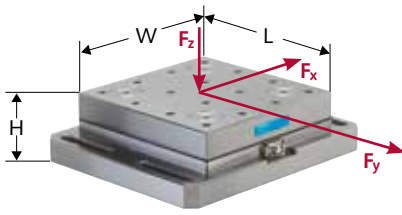

Technical Data	Type	9255C
Measuring range		
$F_x, F_y$	kN	-30 ... 30
$F_z$	kN	-10 ... 60
Calibrated measuring range		
$F_x, F_y$	kN	0 ... 30
	kN	0 ... 3
$F_z$	kN	0 ... 60
	kN	0 ... 6
Sensitivity		
$F_x, F_y$	pC/N	$\approx -7,9$
$F_z$	pC/N	$\approx -3,9$
Natural frequency		
$f_n(x)$	kHz	$\approx 2,2$
$f_n(y)$	kHz	$\approx 2,2$
$f_n(z)$	kHz	$\approx 3,3$
Pretensioning direction		vertical
Operating temperature range		$^{\circ}\text{C}$ -20 ... 70
LxWxH		mm 260x260x95
Weight		kg 52
Degree of protection IEC/EN 60529 (w. conn. cable)		IP67
Connection		Fischer flange 9 pol. neg.

### Characteristics

The robust dynamometer for heavy machining with the largest force range of all of the Dynamometers. The coupling to the machine table is accomplished with lateral flanges with oblong holes.

In addition, the dynamometer can be fastened through the center of the four sensors, thus enhancing the natural frequency.

### Accessories

Connecting cable Type 1687B5/1689B5 (3-comp.)  
Connecting cable Type 1677A5/1679A5 (6-comp.)

**Data sheet** 9255C\_003-051

### CAD Download-Service

<http://kistler.partcommunity.com>

### Applications

Measurement of large forces, mainly while milling, broaching and surface grinding of large structural components.



Milling with dynamometer Type 9255C

# Stationary Dynamometers

## Multi-Component Dynamometer with Top Plate 100x170 mm up to 10 kN

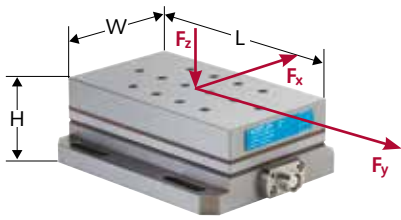

Technical Data	Type	9257B
Measuring range		
F <sub>x</sub> , F <sub>y</sub>	kN	-5 ... 5
F <sub>z</sub>	kN	-5 ... 10
Calibrated measuring range		
F <sub>x</sub> , F <sub>y</sub>	kN	0 ... 5
	kN	0 ... 0,5
F <sub>z</sub>	kN	0 ... 10
	kN	0 ... 1
Sensitivity		
F <sub>x</sub> , F <sub>y</sub>	pC/N	≈-7,5
F <sub>z</sub>	pC/N	≈-3,7
Natural frequency		
f <sub>n</sub> (x), f <sub>n</sub> (y)	kHz	≈2,3
f <sub>n</sub> (z)	kHz	≈3,5
Pretensioning direction		vertical
Operating temperature range		°C 0 ... 70
LxWxH		mm 170x100x60
Weight		kg 7,3
Degree of protection IEC/EN 60529 (w. conn. cable)		IP67
Connection		Fischer flange 9 pol. neg.

### Characteristics

The dynamometer for universal use. The handy size and the ideal measurement range for many applications have made Type 9257B the most frequently built multi-component dynamometer. The connection with the machine table is accomplished with lateral flanges with oblong holes.

### Accessories

Connecting cable Type 1687B5/1689B5 (3-comp.)  
Connecting cable Type 1677A5/1679A5 (6-comp.)  
Toolholder Type 9403

**Data sheet** 9257B\_000-151

### CAD Download-Service

<http://kistler.partcommunity.com>

### Applications

Cutting force measurement while milling, turning, surface grinding and drilling of mid-sized structural components.

# Stationary Dynamometers

## 4-Component Dynamometer for Cutting Force Measurement in Drilling

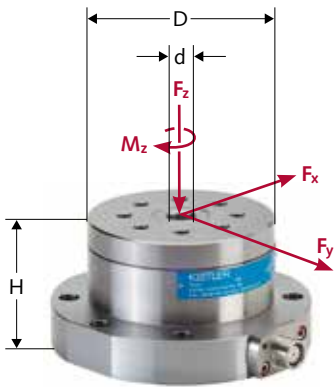

Technical Data	Type	9272
Measuring range		
$F_x, F_y$	kN	-5 ... 5
$F_z$	kN	-5 ... 20
$M_z$	N·m	-200 ... 200
Calibrated measuring range		
$F_x, F_y$	kN	0 ... 5
	kN	0 ... 0,5
$F_z$	kN	0 ... 20
	kN	0 ... 2
$M_z$	N·m	0 ... ±200
	N·m	0 ... ±20
Sensitivity		
$F_x, F_y$	pC/N	≈-7,8
$F_z$	pC/N	≈-3,5
$M_z$	pC/N·m	≈-160
Natural frequency		
$f_n(x), f_n(y)$	kHz	≈3,1
$f_n(z)$	kHz	≈6,3
$f_n(M_z)$	kHz	≈4,2
Pretensioning direction		vertical
Operating temperature range		°C 0 ... 70
DxdxH		mm ø100xø15x70
Weight		kg 4,2
Degree of protection IEC/EN 60529 (w. conn. cable)		IP67
Connection		Fischer flange 9 pol. neg.

### Characteristics

As the only stationary dynamometer, this 4-component dynamometer can, in addition to the three force directions, also measure the torque  $M_z$  directly in the center of the dynamometer. This ensures that a precise determination of the torque is achieved.

### Accessories

Connecting cable Type 1677A5/1679A5  
Toolholder Type 9404

**Data sheet** 9272\_000-153

### CAD Download-Service

<http://kistler.partcommunity.com>

### Applications

Cutting force measurement mainly while drilling. For training purposes, the device can also be utilized for cutting force measurements with milling or turning.



Force measurement during cutting of quartzes with dynamometer Type 9272

# Stationary Dynamometers

## Multi-Component Force Plate with Top Plate 400x600 mm up to 30 kN

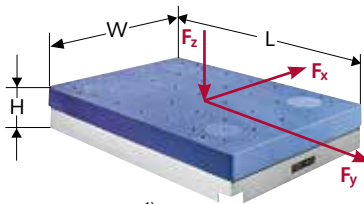

Type 9253B22 <sup>1)</sup>

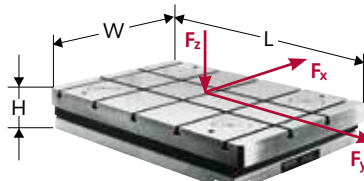

Type 9253B23 <sup>2)</sup>

<sup>1)</sup> Top plate with tapped hole M10x18

<sup>2)</sup> Top plate with T-grooves 10H12

Technical Data	Type	9253B22	9253B23
<b>Measuring range</b>			
$F_x, F_y$	kN	-15 ... 15	-12 ... 12
$F_z$	kN	-15 ... 30	-12 ... 25
<b>Calibrated measuring range</b>			
$F_x, F_y$	kN	0 ... 15	0 ... 12
	kN	0 ... 1,5	0 ... 1,2
$F_z$	kN	0 ... 30	0 ... 25
	kN	0 ... 3	0 ... 2,5
<b>Sensitivity</b>			
$F_x, F_y$	pC/N	$\approx \pm 7,8$	$\approx \pm 7,8$
$F_z$	pC/N	$\approx \pm 3,7$	$\approx \pm 3,7$
<b>Natural frequency</b>			
$f_n(x)$	Hz	$\approx 580$	$\approx 610$
$f_n(y)$	Hz	$\approx 550$	$\approx 570$
$f_n(z)$	Hz	$\approx 720$	$\approx 570$
Pretensioning direction		vertical	vertical
Operating temperature range	°C	-20 ... 70	-20 ... 70
LxWxH	mm	600x400x100	600x400x100
Weight	kg	90	85
Degree of protection IEC/EN 60529 (w. conn. cable)		IP67	IP67
Connection		Fischer flange 9 pol. neg.	Fischer flange 9 pol. neg.

### Characteristics

With a cover plate size of 400x600 mm, even larger workpieces can also be set up securely. The measurement platform is mounted through the center of the four feet on the machine tool table. In doing so, in contrast to all other stationary dynamometers, the base plate is dispensed with.

### Accessories

Connecting cable Type 1687B5  
Connecting cable Type 1677A5

**Data sheet** 9253B\_000-146

### Applications

Cutting force measurement while milling and surface grinding of large-sized structural components.



# Stationary Dynamometers

## Multi-Component Sensor Kit for Force Measurement up to 60 kN

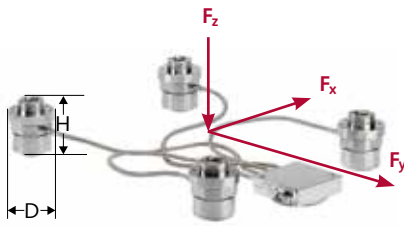

Technical Data	Type	9366CC...
Measuring range		
$F_x, F_y$	kN	-25 ... 25 <sup>1)</sup>
$F_z$	kN	-25 ... 60 <sup>1)</sup>
Calibrated measuring range		
$F_x, F_y$	kN	0 ... 25
	kN	0 ... 2,5
$F_z$	kN	0 ... 60
	kN	0 ... 6
Sensitivity		
$F_x, F_y$	pC/N	≈-7,8
$F_z$	pC/N	≈-3,8
Natural frequency		
$f_n(x), f_n(y), f_n(z)$	Hz	≈200 ... 1 600 <sup>1)</sup>
Pretensioning direction		vertical
Operating temperature range	°C	-20 ... 70
DxH	mm	72x90
Max. size of the top plate	mm	900x900
Weight	kg	7
Degree of protection IEC/EN 60529 (w. conn. cable)		IP67
Connection		Fischer flange 9 pol. neg.

<sup>1)</sup> depending on material and size of the top plate

### Characteristics

This ready-to-connect and calibrated multi-component kit allows the user to assemble multi-component measuring plates. Top plate sizes from 300x300 mm to 900x900 mm are possible.

### Accessories

Connecting cable Type 1687B5 (3-comp.)  
Connecting cable Type 1677A5 (6-comp.)

**Data sheet** 9366CC\_000-681

### CAD Download-Service

<http://kistler.partcommunity.com>

### Applications

Cutting force measurement while milling and surface grinding of large-sized structural components.



Milling of Titanium on dynamometer Type 9366CC...

# Rotating Dynamometers

## Rotating 4-Component Dynamometer RCD for Cutting Force Measurement up to 20 000 1/min

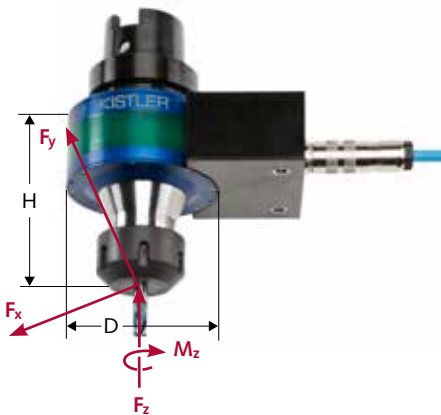

Technical Data	Type	9170A...
Measuring range nominal		
$F_x, F_y$	kN	-5 ... 5 <sup>1)</sup>
$F_z$	kN	-20 ... 20 <sup>1)</sup>
$M_z$	N·m	-150 ... 150 <sup>1)</sup>
Speed, max.	1/min	20 000 <sup>1)</sup>
Sensitivity (min./max.)		
$F_x, F_y$	mV/N	≈2/≈20
$F_z$	mV/N	≈0,5/≈5
$M_z$	mV/N·m	≈66/≈1 000
Natural frequency		
$f_n(x)$	kHz	≈2 <sup>2)</sup>
$f_n(y)$	kHz	≈2 <sup>2)</sup>
$f_n(z)$	kHz	≈7,6 <sup>2)</sup>
Operating temperature range	°C	0 ... 60
DxH	mm	85x95
Weight of Rotor	kg	1,6 <sup>2)</sup>
Degree of protection IEC/EN 60529 (w. conn. cable)		IP67
Signal transmission		non-contacting

<sup>1)</sup> depending on spindle adaptor and point of force application

<sup>2)</sup> applies to rotor with spindle adaptor HSK-A63 and integrated ER type collet chuck adaptor (without tool)

### Characteristics

With this rotating 4-component dynamometer (RCD), measurements are taken of the forces in radial direction ( $F_x, F_y$ ) and in axial direction ( $F_z$ ) and the torque in the machining processes with spindle speeds of up to 20 000 1/min. An internal supply of coolants is possible. A wide variety of conventional spindle adaptors is available for this RCD.

### Accessories

Collet chuck Type 9169A...

**Data sheet** 9170A\_000-995

### CAD Download-Service

<http://kistler.partcommunity.com>

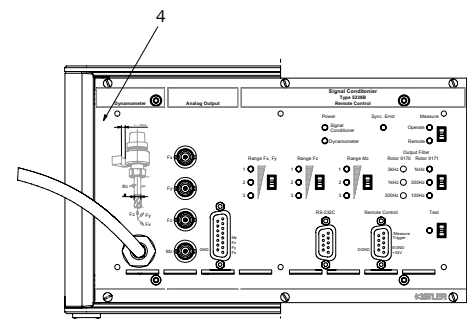
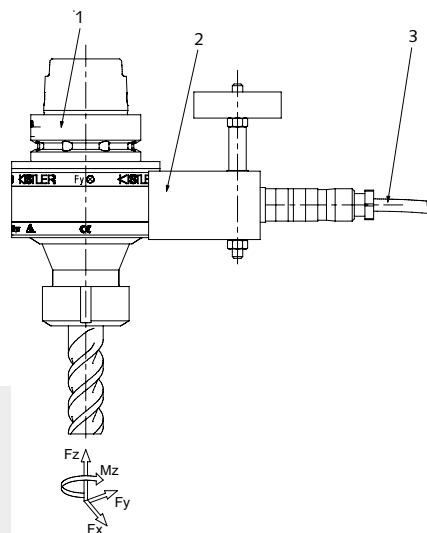

### Applications

4-Component force and torque measurement on rotating tools while drilling and milling (finishing process).

1 Rotor Type 9170A...

2 Stator Type 5236B

3 Cable Type 1500A95, L = 10 m

4 Signal Conditioner Type 5238B1/B2

# Rotating Dynamometers

## Rotating 4-Component Dynamometer RCD for Measuring Cutting Forces in Heavy Machining up to 12 000 1/min

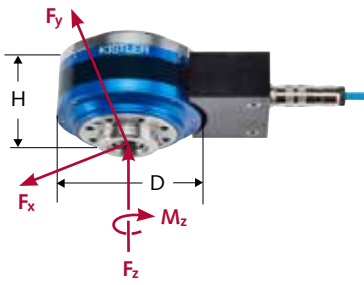

Technical Data	Type	9171A...
Measuring range nominal		
$F_x, F_y$	kN	-20 ... 20
$F_z$	kN	-30 ... 30
$M_z$	N·m	-1 000 ... 1 000
Speed, max.	1/min	12 000
Sensitivity (min./max.)		
$F_x, F_y$	mV/N	≈0,5/≈4,8
$F_z$	mV/N	≈0,3/≈4,8
$M_z$	mV/N·m	≈9/≈96
Natural frequency		
$f_n(x)$	kHz	≈1,1 <sup>1)</sup>
$f_n(y)$	kHz	≈1,1 <sup>1)</sup>
$f_n(z)$	kHz	≈7,6 <sup>1)</sup>
Operating temperature range	°C	0 ... 60
DxH	mm	118x85
Weight	kg	3,3 <sup>2)</sup>
Degree of protection IEC/EN 60529		IP67
Signal transmission		non-contacting

<sup>1)</sup> applies to rotor with spindle adaptor HSK-A100 and without toolholder

<sup>2)</sup> applies to rotor without spindle adaptor and without toolholder

### Characteristics

This rotating 4-component dynamometer (RCD) is – due to its large measuring range and a spindle speed up to 12 000 1/min – particularly suitable for applications in high-performance cutting. The rotor has a modular design which means that various spindle adaptors and toolholders can be easily flange-mounted. An internal supply of coolants is possible. The transmission of the measurement signals and the energy supply takes place contact-free and thus completely without any wearing.

### Accessories

Toolholder according to data sheet  
Spindle adaptor according to data sheet

**Data sheet** 9171A\_003-155

### CAD Download-Service

<http://kistler.partcommunity.com>

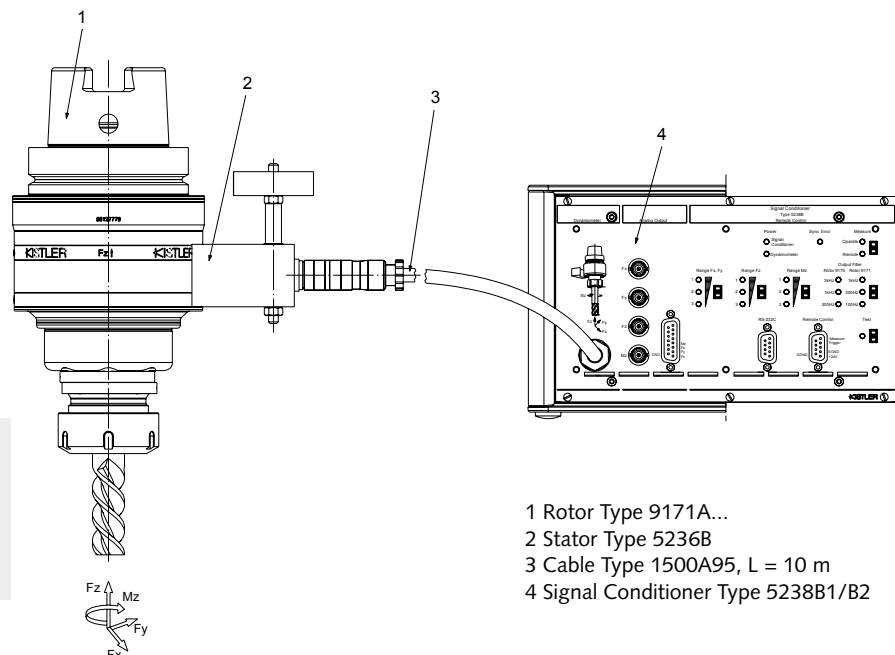

### Applications

4-component force and torque measurement on rotating tools while drilling as well as milling (roughing process). Especially suited for high-performance cutting.

- 1 Rotor Type 9171A...
- 2 Stator Type 5236B
- 3 Cable Type 1500A95, L = 10 m
- 4 Signal Conditioner Type 5238B1/B2

# Amplifying & Acquiring.



Charge amplifier Type 5080A...

## Charge Amplifiers

Signal processing is of special significance for the measurement of mechanical variables such as force and torque. Piezoelectric sensors emit a charge that is proportional to the load on the sensor. The charge amplifier converts this charge into standardized voltage signals that can then be evaluated by the downstream signal processing. In order to fulfill the different requirements in everyday practice, Kistler offers a wide spectrum of charge amplifiers that differ from one another essentially in terms of design, number of measuring channels, accuracy and measuring range.

## Data Acquisition Systems

PCs are usually used for measurement data acquisition. Here special demands are made of the software for the visualization and evaluation of the force signals with respect to functionality and user-friendliness. Kistler DynoWare is an all-purpose, easy-to-use software that is particularly suitable for force measurements with Dynamometers or single-component and multi-component force sensors. For signal analysis, DynoWare offers the users online visualization of the measurement curves in addition to useful calculation and graphics functions.

DynoWare supports the simple configuration of all of the charge amplifiers and Signal Conditioners available for cutting force measurement. In addition, it offers individual documentation of the measurement and saving of configuration and measurement data.

# Charge Amplifier

## High-End Multi-Channel Charge Amplifier for Multi-Component Force Measurement



Technical Data	Type	5080A...
Number of channels		1 ... 8
Measuring range FS	pC	±2 ... 2 200 000
Measuring range adjustment		continuous
Frequency range (-3 dB)	kHz	0 ... 200
Output signal	V	±10 / -8 ... 10
Module optional		- charge amplifier - Dual Mode (charge/Piezotron)
Power supply	VAC	100 ... 240
	VDC	11 ... 36
Input signal	Type/ connector	Piezoelectric, optional with: - BNC neg. - Fischer 9 pol. neg.
Output signal	Type/ connector	- BNC neg. - D-Sub 15-pol. neg.
Degree of protection IEC/EN 60529		IP40
Interface		- RS-232C - USB 2.0
Case, optional		- 19" rack module (DIN 41494) - Desktop unit with support bracket
Other features		Display of mechanical measurands

### Characteristics

This charge amplifier has outstanding properties that make very precise measurements possible, particularly with small forces. It is exceptionally flexible in construction and can be modified to meet requirements at any time. In addition to purely charge amplifier modules, Dual-mode modules are also available to which sensors with charge output and sensors with integrated electronics (Piezotron®) can be connected.

### Accessories

RS-232C cable Type 1200A27  
Connecting cable Type 1700A111A2  
Connecting cable Type 1700A113A2  
Inductive proximity switch Type 2233B

**Data sheet** 5080A\_000-744

### CAD Download-Service

<http://kistler.partcommunity.com>

### Applications

Laboratory charge amplifier for stationary dynamometers. Specially suitable for micro-machining.

# Charge Amplifier

## Multi-Channel Charge Amplifier for Multi-Component Force Measurement



Technical Data	Type	5070A...
Number of channels		
Type 5070Ax0xxx		4
Type 5070Ax1xxx		8
Type 5070Ax2xxx		8 with 6-component summing calculator
Measuring range FS, optional	pC	±200 ... 200 000
	pC	±600 ... 600 000
Measuring ranges adjustment		continuous
Frequency range (-3 dB)	kHz	≈0 ... 45
Output signal	V	±10
Supply voltage	VAC	100 ... 240
Input signal	Type/ connector	Piezoelectric, optional with: – BNC neg. – Fischer 9 pol. neg.
Output signal	Type/ connector	D-Sub 15 pol. neg.
Degree of protection IEC/EN 60529		IP40
Interface, optional		RS-232C RS-232C + IEEE-488
Case, optional		– 19" cassette for rack mounting – Desktop unit with support bracket – 19" cassette with panel mounting set
Other features		– Display of peak values – Display of mechanical measurands

### Characteristics

This charge amplifier was developed especially for multi-component force measurement. Thanks to its large and continuously adjustable measuring ranges and the wide frequency range, this device is suitable in measuring chains with stationary Dynamometers for cutting force measurement.

### Accessories

RS-232C cable Type 1200A27  
Connecting cable Type 1700A111A2  
Connecting cable Type 1700A113A2  
Inductive proximity switch Type 2233B

**Data sheet** 5070A\_000-485

### CAD Download-Service

<http://kistler.partcommunity.com>

### Applications

Laboratory charge amplifier for stationary dynamometers for all types of cutting force measurement.

# Charge Amplifier Module

## Charge Amplifier Module for National Instruments' CompactRIO™ Embedded Control System



Technical Data	Type	5171A...
Number of measuring channels		
Type 5171A1		1
Type 5171A4		4
Measuring range	pC	±1 000 ... 1 000 000
ADC resolution	Bit	24
Sampling rate max.	kS/s	50,78
Frequency range (-3dB)		
Range FS ≤10 000 pC	Hz	≈0 ... 20 000
Range FS >10 000 pC	Hz	≈0 ... 2 000
Input signal (connector)	Type	BNC neg.
Degree of protection IEC/EN 60529		IP40
Dimensions	mm	23x88,1x87,5
Weight	kg	0,2

### Characteristics

The charge amplifier module Type 5171A... allows a very convenient integration of piezo-electric sensors into NI CompactRIO™ applications. The charge signals of the sensors are directly digitized with 24 bit and can then be processed by the FPGA and the real-time operating system. For the best possible resolution, four hardware measuring ranges have been implemented. Reset/Measure signal, range selection and data transfer are all controlled and programmed with the appropriate LabVIEW™ tools. For the users convenience the channel status is indicated by an LED on the module itself.

**Data sheet** 5171A\_003-147

NI CompactRIO™ and LabVIEW™ are registered trademarks of National Instruments Corporation.

### Applications

Universal charge amplifier module for direct integration into National Instruments CompactRIO™-Module.

# Data Acquisition System

## DAQ-System for Data Acquisition of up to 28 Measuring Channels



Technical Data	Type	5697A...
Number of measuring channels		28
Resolution	Bit	16
Sampling rate max.		
with 1 channel	kS/s	1 000
with 8 channels	kS/s	125
with 16 channels	kS/s	62,5
Interface to PC		USB 2.0 Type B, fem.
Dimensions	mm	208x70x249
Weight	kg	2,2

### Applications

Together with the DynoWare software, this data acquisition system is used in all types of cutting force measurement.

### Characteristics

This all-purpose data acquisition system enables the acquisition of analog signals with up to 1 MHz. In combination with the DynoWare software, all Kistler laboratory charge amplifiers and signal conditioners can be controlled. The connection with the PC is via a USB interface. The DynoWare software is obtainable in the package with data acquisition system.

### Accessories

RS-232C cable Type 1200A27  
Connecting cable Type 1700A111A2  
Connecting cable Type 1700A113A2  
Inductive proximity switch Type 2233B

**Data sheet** 5697\_000-745

## Software

### DynoWare – Windows® Software for Data Acquisition

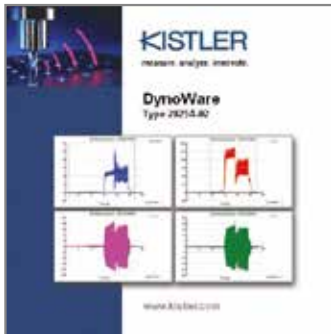

Technical Data	Type	2825A...
Supported charge amplifiers	Types	5011, 5015A..., 5018A..., 5017, 5019, 5070A..., 5080A...
Supported Signal Conditioners for rotating dynamometers (RCD)	Types	5223B..., 5237A... 5238B...
Additional information		see Data sheet
Supported operating systems		Windows® 7 Windows® 8

Windows® is a registered trade mark of Microsoft Corporation

### Characteristics

This simple-to-operate software enables the configuration and control of all Kistler laboratory charge amplifiers and signal conditioners via RS-232C, IEEE-488 or USB. In addition, it offers the simultaneous recording of the measurement signals as well as useful signal evaluation and calculation functions. The measurement data acquired can be readily exported. The software is suitable for the acquisition and evaluation of any and all physical variables.

### Accessories

Data acquisition system Type 5697A...

**Data sheet** 2825A\_000-371

### Applications

DynoWare is particularly suitable for the recording and evaluation of cutting force signals.



## Connecting Cables, High Insulation

Cable, 8-Core / 3-Core, Temperature Range -5 ... 70 °C

Technical Data	Type	1677A5	1687B5
 Connection		Fischer 9 pol. pos., flange	Fischer 9 pol. pos., flange
		Fischer 9pol. pos	Fischer 9 pol. pos
Length	m	5	5
Diameter	mm	12,3 (metal sheath)	12,3 (metal sheath)
Number of conductors		8	3
Used for		6-component measurement	3-component measurement

Cable with Angle Connector, 8-Core / 3-Core, Temperature Range -5 ... 70 °C

Technical Data	Type	1679A5	1689B5
 Connection		Fischer angle 9 pol. pos., flange	Fischer angle 9 pol. pos., flange
		Fischer 9 pol. pos	Fischer 9 pol. pos
Length	m	5	5
Diameter	mm	12,3 (metal sheath)	12,3 (metal sheath)
Number of conductors		8	3
Used for		6-component measurement	3-component measurement

Data sheet 1687B\_000-545

## Connecting Cables, Low-Resistance

Cable for Transmission of the Measuring Signals

Technical Data	Type	1700A111A2
 Connection		D-Sub 15 pol. neg.
		D-Sub 15 pol. pos.
Length	m	2
Number of conductors		15

Cable for Transmission of the Measuring Signals

Technical Data	Type	1700A113A2
 Connection		D-Sub 15 pol. neg.
		BNC pos.
Length	m	2
Number of conductors		8







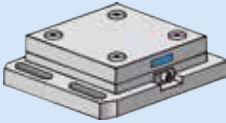

Cable for Transmission of the Communication Signals

Technical Data	Type	1200A27
 Connection		D-Sub 9 pol. pos.
		D-Sub 9 pol. neg.
Length	m	5
Number of conductors		9

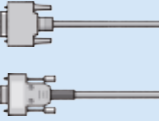

Data sheet 5697\_000-745

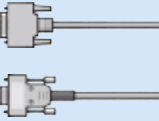
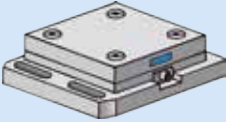
# Measuring Chains.

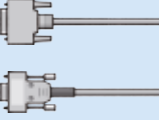
## Stationary Dynamometers

	Measuring	Connecting	Amplifying	
3 Measuring Components	9119AA1 9119AA2 9129AA 9139AA 9253B... 9255C 9257B 9366CC... 	1687B5 1689B5 	5070A... 5080A... 	1700A111A2 1200A27 
4 Measuring Components	9272 	1677A5 1679A5 	5070A... 5080A... 	1700A111A2 1200A27 
8 Measuring Components	9119AA1 9119AA2 9129AA 9139AA 9253B... 9255C 9257B 9366CC... 	1677A5 1679A5 	5070A... 5080A... 	1700A111A2 1200A27 

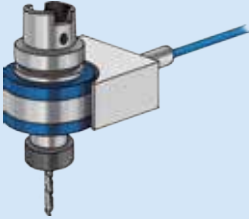
## Rotating Dynamometers (RCD)

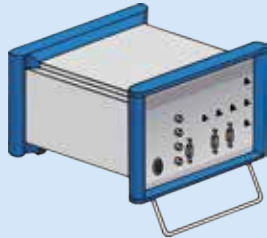
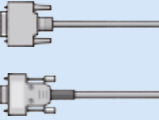
Rotating Dynamometers	9170A... 9171A... 5236B 	1500A95 	5238B... 	1700A111A2 1200A27 
-----------------------	--	--	---	--

**Acquiring**

**Analyzing**

5697A...

USB cable

Notebook  
with DynoWare Software

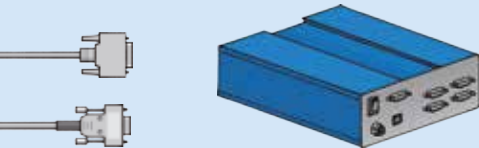

5697A...

USB cable

Notebook  
with DynoWare Software

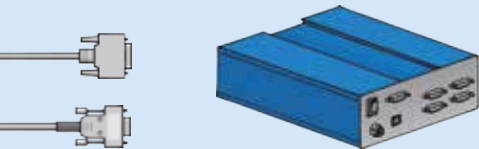

5697A...

USB cable

Notebook  
with DynoWare Software

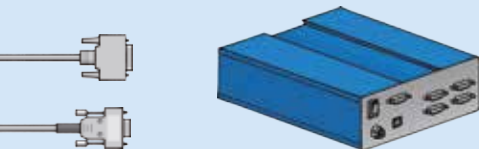

5697A...

USB cable

Notebook  
with DynoWare Software

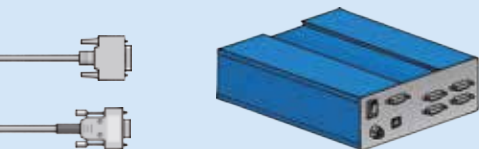

**Kistler Group**

Eulachstrasse 22

8408 Winterthur

Switzerland

Tel. +41 52 224 11 11

Kistler Group includes the Kistler Holding AG and  
all its subsidiaries in Europe, Asia, Americas and Australia.

Find your local contact on  
[www.kistler.com](http://www.kistler.com)

**KISTLER**  
measure. analyze. innovate.